

ERSATZTEILE
SPARE PARTS

**AGR / GRX Premium Dichtungen
für emaillierte Stutzen bis DN 400**

**AGR / GRX Premium gaskets
for glass lined nozzles up to ND 14"**

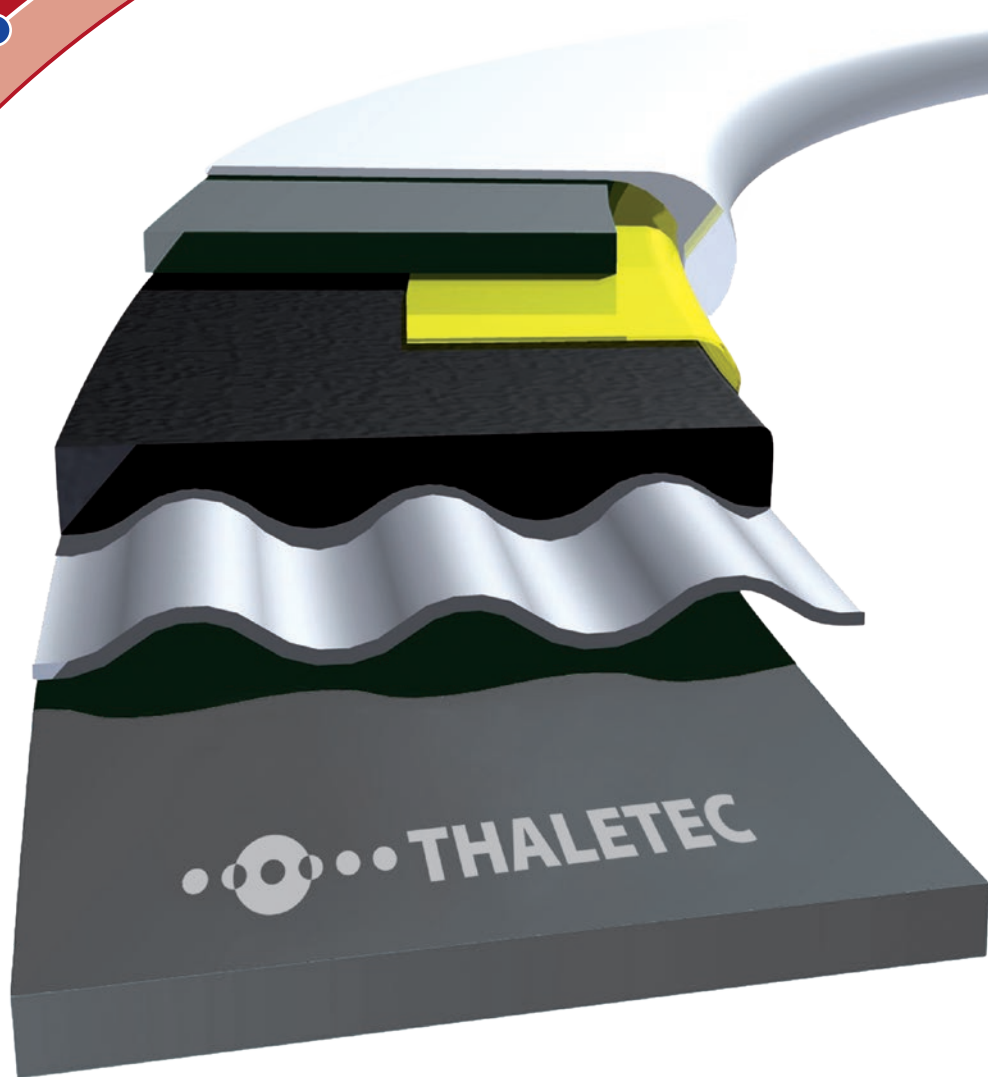

Emallierte Stutzen bis DN 400 Glass lined nozzles up to ND 16"

Merkmal



- Zugelassen nach TA Luft
- Temperatur Bereich -60/+230 °C
- Mit Diffusionssperre

Features

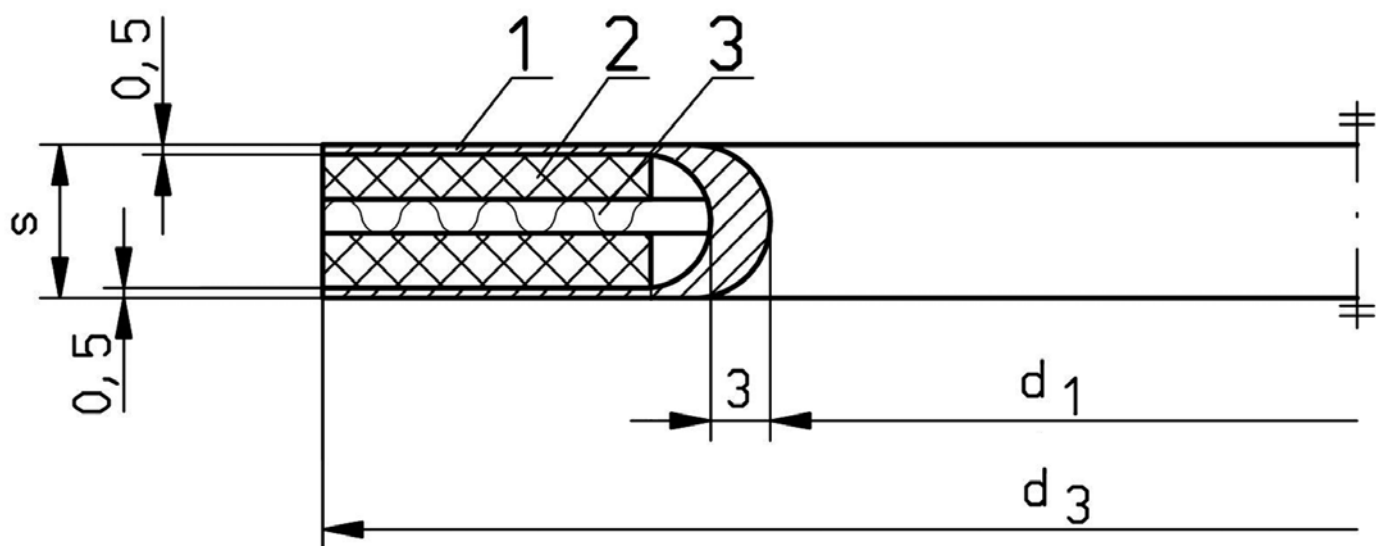

- Authorized according to „TA Luft“
- Temperature range: -60/+230 °C
- with reinforced PTFE- envelope (diffusion barrier)



Pos. Werkstoffe

- | | |
|---|--|
| 1 | Virginales PTFE mit FDA Zertifikat |
| 2 | AGR Premium (Flyer K025 )
GRX Premium (Flyer K099 ) |
| 3 | Wellring aus rostfreiem Stahl |

Materials

Virginal PTFE with FDA Certificate
AGR Premium (Flyer K025 )
GRX Premium (Flyer K099 )
Corrugated Ring made of Stainless Steel

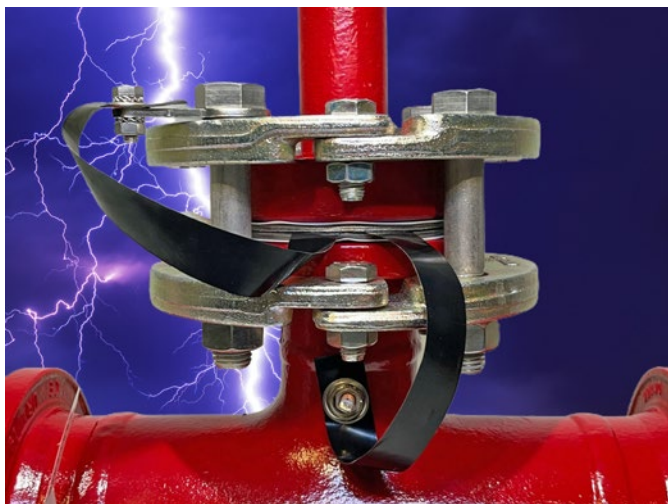

Dichtungen mit einer Einlage aus GRX Premium können jederzeit, auch nachträglich, mit einer Erdungslasche - THALETEC ConduStrip gemäß Flyer K159) versehen werden

Gaskets with a GRX Premium insert can be fitted with a grounding strap - THALETEC ConduStrip according to flyer K159) - at any time, even subsequently.

Dichtungen gemäß DIN 28148 ohne Erdungslasche / Dichtungseinlagewerkstoff THALETEC AGR / GRX Premium
Gaskets according to DIN 28148 without earthing lug / Gasket insert THALETEC AGR / GRX Premium

Teile-Nr./ Part-No. AGR	GRX	DN	ND	PS* [bar]	d1 [mm]	d3 [mm]	s* [mm]
19021459	19028971	25	1"	40	31	65	5
19021460	19028972	32		40	39	75	5
19021461	19028973	40		40	47	85	5
19021462	19028974	50	2"	40	59	100	5
19021463	19028975	65		40	75	120	5
19021464	19028976	80	3"	40	89	135	5
19021465	19028977	100	4"	40	113	160	5
19021467	19028979	125	5"	40	132	185	5
19021469	19028981	150	6"	40	161	210	5
19021471	19028983	200	8"	25	212	265	5
19021473	19028985	250	10"	25	262	315	5
19021475	19028987	300	12"	25	310	365	10
19021476	19028988	400	14"	25	411	480	10

Dichtungen gemäß DIN 28148 mit Erdungslasche / Dichtungseinlagewerkstoff THALETEC AGR Premium
Gaskets according to DIN 28148 with earthing lug / Gasket insert THALETEC AGR Premium

Teile-Nr./ Part-No. AGR	GRX	DN	ND	PS* [bar]	d1 [mm]	d3 [mm]	s* [mm]
19023524	19029240	25	1"	40	31	65	5
19023525	19029241	32		40	39	75	5
19023526	19029242	40		40	47	85	5
19023527	19029243	50	2"	40	59	100	5
19023528	19029244	65		40	75	120	5
19023529	19029245	80	3"	40	89	135	5
19021466	19028978	100	4"	40	113	160	5
19021468	19028980	125	5"	40	132	185	5
19021470	19028982	150	6"	40	161	210	5
19021472	19028984	200	8"	25	212	265	5
19021474	19028986	250	10"	25	262	315	5
19023522	19029246	300	12"	25	310	365	10
19023523	19029247	400	14"	25	411	480	10

*PS[bar]: Maximal zulässiger Druck. Die Flanschverbindung muss dafür ausgelegt sein.
Maximum allowable pressure. The flange connection has to be designed accordingly.

*s[mm]: Dichtungsdicke nach DIN 28148 in ungepresstem Zustand.
Gasket thickness according to DIN 28148, not compressed.

Die detaillierte Beschreibung unserer AGR PREMIUM Dichtung finden Sie in unserem Katalogblatt K025 und die detaillierte Beschreibung unserer GRX PREMIUM Dichtung finden Sie in unserem Katalogblatt K099. Dichtungen für Hauptflansche und Mannloch-Stutzen sind in unserem Ersatzteilkatalog S004 beschrieben.

The detailed description of our AGR PREMIUM gasket can be found in our catalogue K025 and you will find the detailed description of our GRX PREMIUM gasket in our catalogue K099. Gaskets for main flanges and manhole nozzles are described in our spare parts catalogue S004.

Wir beraten Sie gern zu unserem Produktsortiment:

- Emaillierte Rührbehälter nach DIN 28136
- Spezialrührbehälter für die pharmazeutische Industrie
- Komponenten für die Pharma-Apparatetechnik
- Rührwerke und -systeme für die chemische und pharmazeutische Industrie
- Polymerisationsapparate
- Lagertanks und Vorlagen
- Kolonnen
- Emaillierte Wärmetauscher
- Mess- und Analysetechnik
- Zubehör

We would like to advice you regarding the advantages of glass lined equipment like:

- Glass lined reactors acc. to DIN 28136
- Glass lined Pharma Reactors
- Components for pharmaceutical and high purity applications
- Mixing technology for pharmaceutical and chemical industry
- Reactors for Polymerization
- Storage Tanks and Receivers
- Columns
- Heat Exchangers
- Sensor technology
- Accessories

www.thaletec.com

THALETEC

Rund-um-Service
all-round service

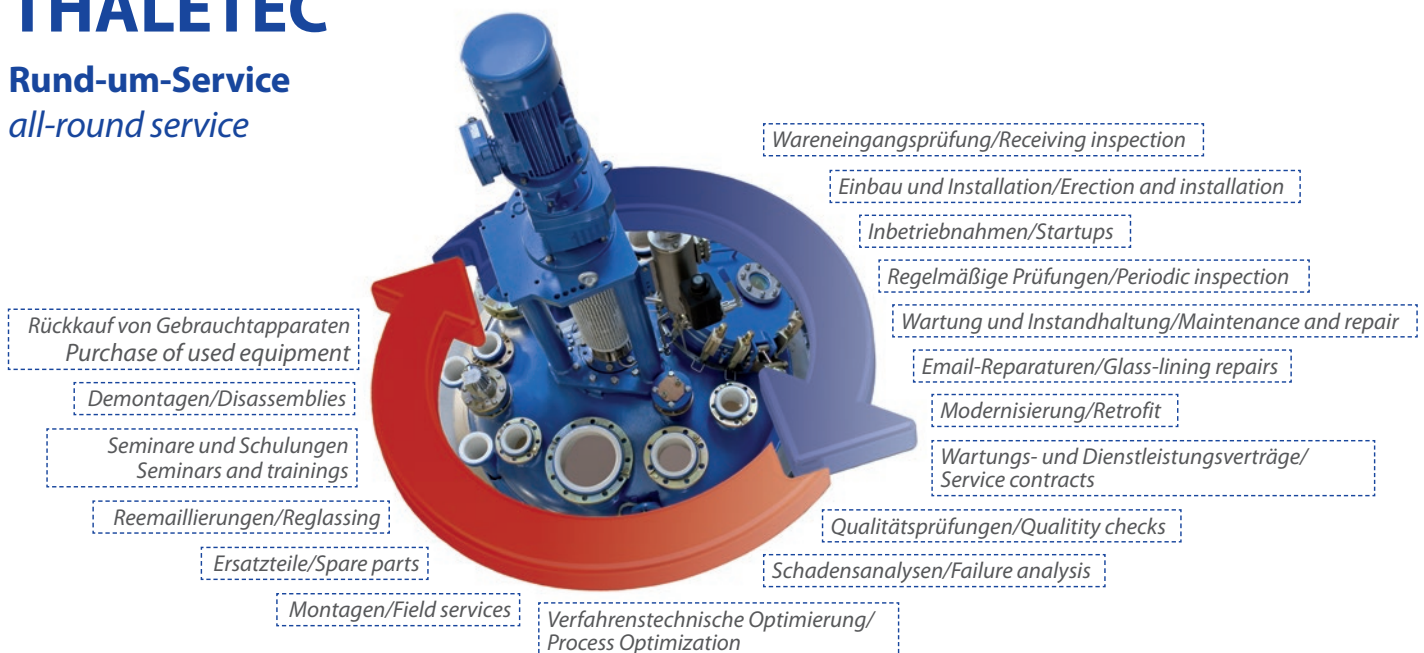

THALETEC GmbH

Steinbachstraße 3
D - 06502 Thale

+ 49 (0) 3947 778-0
+ 49 (0) 3947 778-130

Hotline:

+ 49 (0) 3947 778-111
service@thaletec.com
www.thaletec.com

